



**colorex<sup>®</sup>**

Protecting your technology

**colorex<sup>®</sup> SD**  
**colorex<sup>®</sup> EC**  
**colorex<sup>®</sup> plus**

creating better environments

**Forbo**

FLOORING SYSTEMS



# Protecting your technology.

Colorex is an advanced technical flooring system specifically designed to control static discharge in sensitive areas such as cleanrooms, operating theatres and the electronics industry. Not only does Colorex provide an advanced technical solution, it is also aesthetically pleasing, enhancing any commercial interior from industrial to educational establishments.

### Providing peace of mind

Forbo Flooring Systems is an international market leader with a wealth of experience in providing ESD and clean room flooring with probably the best known brand in the market place - Colorex. You can have peace of mind that Colorex complies to every standard and norm that is required today and likely to be required tomorrow.

### Environmental credentials

We constantly strive to produce sustainable flooring systems that create better environments everywhere. At the same time we help take care of the natural environment through our commitment to sustainable development, responsible raw material procurement and manufacturing processes. For example our Colorex collection contains 15% post industrial recycled content, is manufactured using green electricity and is REACH compliant.

## The 8 benefits of Colorex

Colorex is the ideal flooring system for sectors such as electronics, pharmaceuticals, health, data centres and server rooms..

- 1 Colorex offers peace of mind as it fully complies with all ESD and clean room standards, including the Fraunhofer institute.**
- 2 Colorex offers a life time conductivity warranty guaranteeing optimal performance throughout the life of the product**
- 3 The dense construction of Colorex provides a porefree surface ensuring the highest hygiene properties**
- 4 The low plasticiser content in Colorex tile creates a unique dimensional stability and prevents shrinkage**
- 5 The low plasticiser content also ensures extremely low emissions and outgassing making Colorex the right choice for clean rooms**
- 6 The surface of Colorex can be fully repaired extending the useful life of the product**
- 7 The dense construction of Colorex provides excellent resistance to heavy loads making it an ideal solution for commercial and industrial environments**
- 8 Colorex is available in tile format, a prerequisite for raised access floors found in many commercial environments such as data centres and server rooms.**

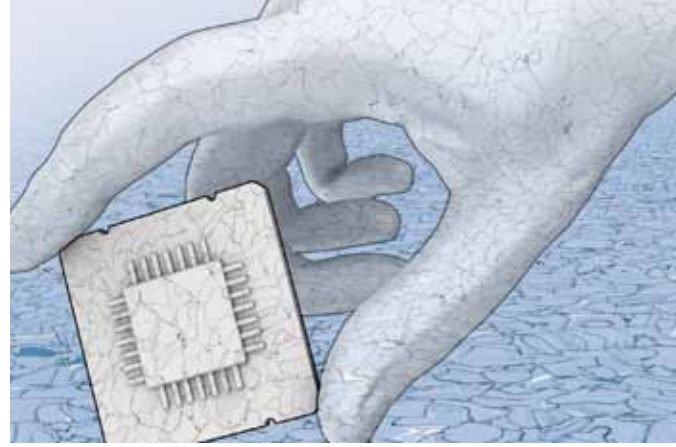

ESD flooring

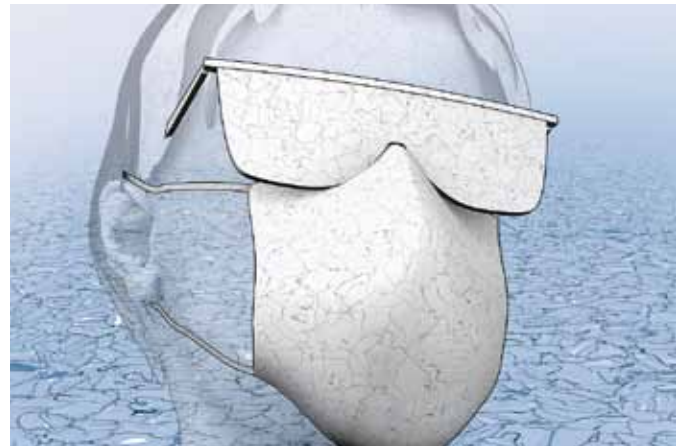

Cleanroom flooring

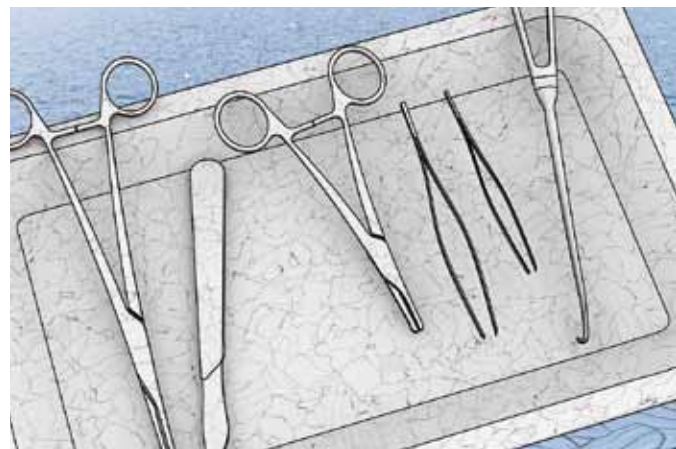

Health care flooring

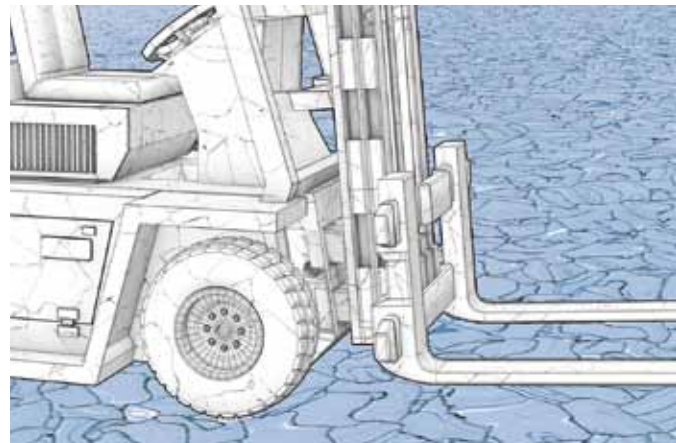

Industrial flooring

# We start where others stop

Colorex is only available in tile format as this enables quicker installation, especially in small and medium areas or rooms with irregular shapes. The tile format also ensures less wastage than sheet, making it the environmentally preferable option.

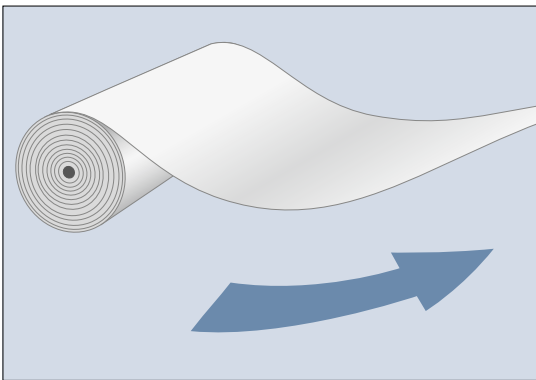

Colorex provides all the features normally associated with ESD sheet product but with the additional benefits mentioned above that the tile format offers. ESD sheet products require a high plastiscer content which can result in out-gassing. In contrast, Colorex tiles have a small percentage of plastiscer content and as a result, very low out-gassing.

## Construction Colorex

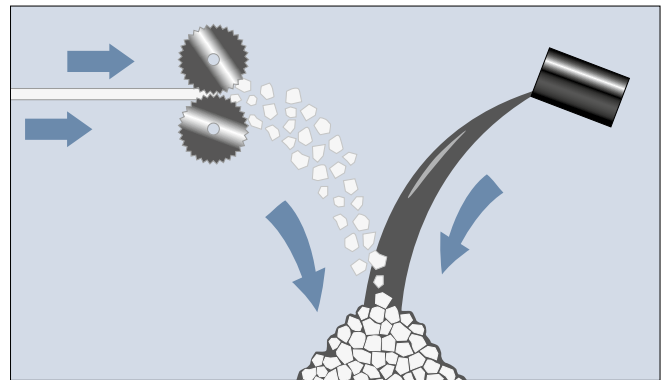
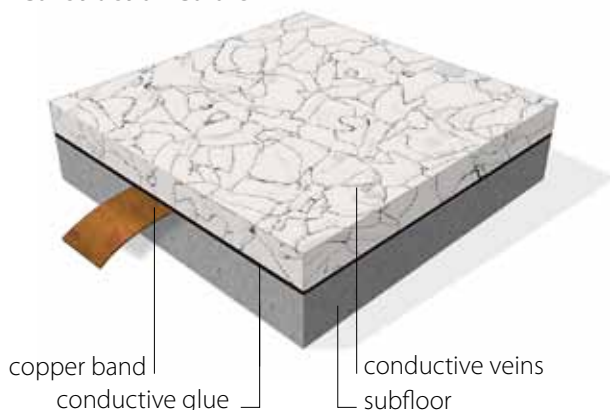

## Step 1: Chips and conductive coating

Small vinyl chips are coated with a conductive substance.

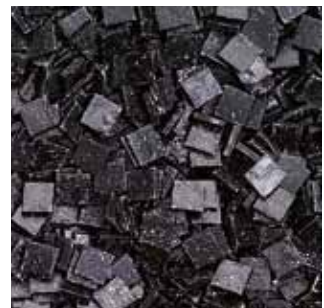

## Advantages

- The conductive coating on the chips ensures that the unique electro static dissipative properties are consistent throughout the product.
- The construction guarantees a life long conductivity that remains unaffected by changes in humidity and temperature.

As Colorex also has very low plasticiser content there's no need to worry about emissions or shrinkage and the corresponding diminishing of conductive properties. Our production process produces a material of superior and consistent quality with an extremely high and uniform compression. The easy-clean surface is pore free, making it suitable for the most stringent hygiene requirements, right up to certified cleanrooms.

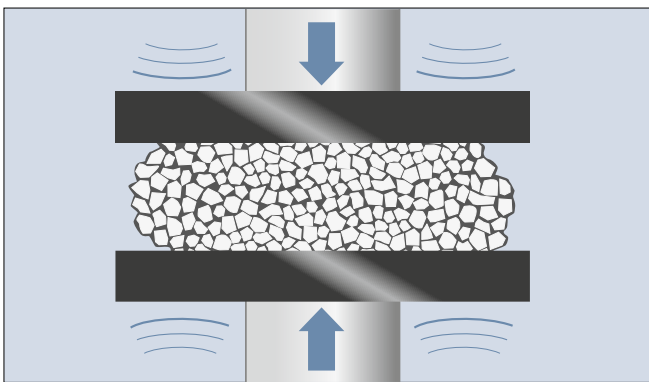

### Step 2: High pressure production

By applying very high pressure and a high temperature, these coated chips are then compressed into solid blocks of homogeneous material.

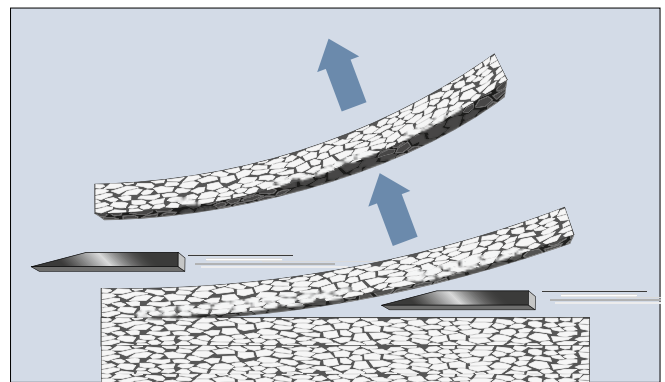

### Step 3: Splitting and surface treatment

Colorex tiles are cut from the solid blocks of homogenous material and machine finished to provide a pore free surface.

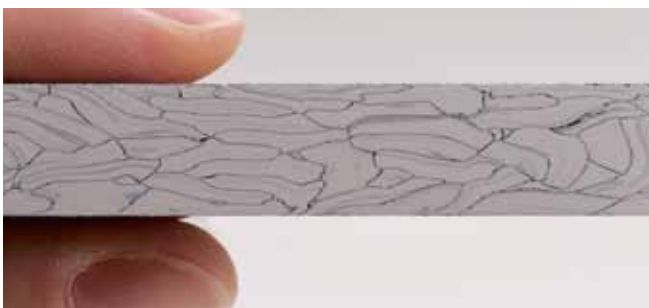

### Advantages

- Take a look at the semi-finished product above and you'll see that the conductive coating on the chips forms a dense network of tiny black veins
- These are the 'conductor paths' that enable safe electrostatic discharge through the whole thickness of the tile



### Advantages

- The tiles are easy to work with and allow for straightforward installation and reduced installation waste when compared to sheet products.
- Colorex is a highly compressed tile with a compact, pore free, easy clean and repairable surface

# The Colorex system

Colorex can be used in many different applications. It can be installed by fully adhering it directly to a subfloor or bonding it to a raised access floor panel. It can also be laid as part of a loose lay tile system. Colorex is available with three levels of conductivity, each of which can be installed as described above. The loose lay slip resistant version (R11 plus) completes the comprehensive Colorex high tech solutions offer.

		Highperformance			
1	2		<b>Colorex EC</b>	<b>Colorex EC plus</b>	3
		<b>Functionality</b>	Permanently conductive	Permanently conductive	
		<b>Description</b>	Permanently conductive floor, connection between tiles through conductive adhesive and connected to earth through copper strip. Compliant to IEC 61340-4-5 with appropriate ESD shoes	Permanently conductive floor, connection between tiles through dovetails and connected to earth with copper strip. Compliant to IEC 61340-4-5 with appropriate ESD shoes	
	<b>Application area</b>	ESD facilities, cleanrooms, pharmaceutical laboratories, production sites and operating theatres.	Renovation of ESD facilities, cleanrooms, pharmaceutical laboratories and production sites. Suitable when down time, damp floors or poor sub floors are an issue		
		Performance			
1	2		<b>Colorex SD</b>	<b>Colorex SD plus (on request only)</b>	3
		<b>Functionality</b>	Permanently static dissipative	Permanently static dissipative	
		<b>Description</b>	Permanently static dissipative floor, connection between tiles through conductive adhesive and connected to earth through copper strip.	Permanently static dissipative floor, connection between tiles through dovetails and connected to earth with copper strip.	
	<b>Application area</b>	New build laboratories, clean rooms, pharmaceutical laboratories, production sites and operating theatres.	Renovation of laboratories, clean rooms, pharmaceutical laboratories and production sites. Suitable when down time, damp floors or poor sub floors are an issue		
		Standard			
1	2		<b>Colorex Basic (on request only)</b>	<b>Colorex Basic plus</b>	3
		<b>Functionality</b>	Resistant / repairable	Resistant / repairable	
		<b>Description</b>	Excellent chemical resistance. Floor can be repaired in case of heavy damages.	Excellent chemical resistance. Floor can be repaired in case of heavy damages.	
	<b>Application area</b>	Shops, stores, warehouses. Areas with high traffic needing daily intensive cleaning.	Shops, stores, warehouses. Areas with high traffic needing daily intensive cleaning. Suitable when down time, damp floors or poor sub floors are an issue		

# Colorex EC

## High performance

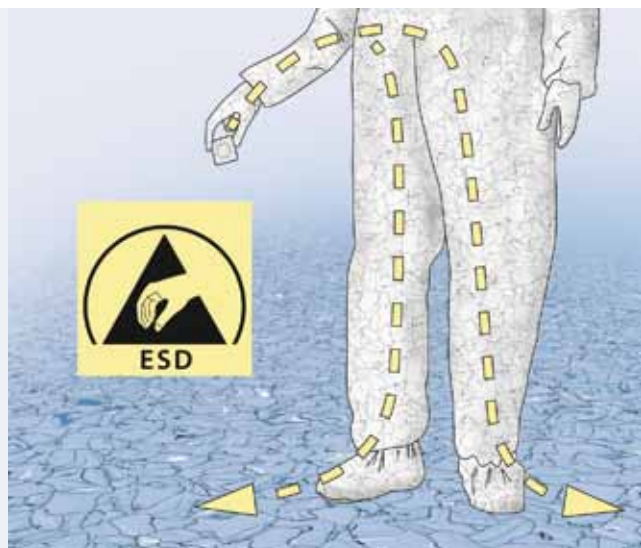

With Colorex EC, static charges flow easily through the dense network of tiny conductive veins that run through the whole thickness of the tile. The charge is transmitted via the conductive adhesive and securely discharged to earth via the copper strip. It's a completely natural system that needs no volatile, chemical anti-static additives to aid conductivity. The conductivity is not affected by changes in temperature or humidity.

**Functionality:** Permanently conductive

**Description:** Permanently conductive floor, connection between tiles through conductive adhesive and connected to earth through a copper strip. Compliant to IEC 61340-4-5 with appropriate ESD shoes

**Application areas:** ESD facilities, cleanrooms, pharmaceutical laboratories, production sites and operating theatres.

## Finishing solutions

In highly sensitive health care areas, and anywhere that has strict hygiene requirements, it's vital that floor-to-wall transitions are water-tight, perfectly hygienic and aesthetically pleasing. Our integrated coving system creates a perfect seal for these critical areas using the same Colorex material. The system is available in every colour in our collection and consists of the following parts:

### Cove skirting strip

The cove skirting strip, which is available in rolls, is cut and welded from Colorex material providing consistent quality from wall to wall. The cove skirting can be formed up the wall by the use of a cove former ie an underlying profile which ensures a smooth transition between wall and floor and avoids right angle joints which may trap dirt.

12.2 m long, standard height 15 cm (5 cm on the floor plus 10 cm up the wall)

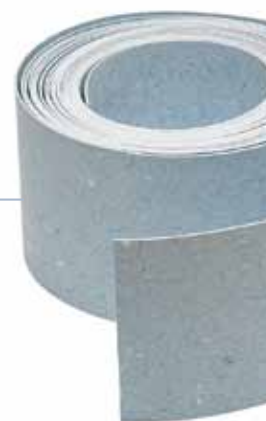

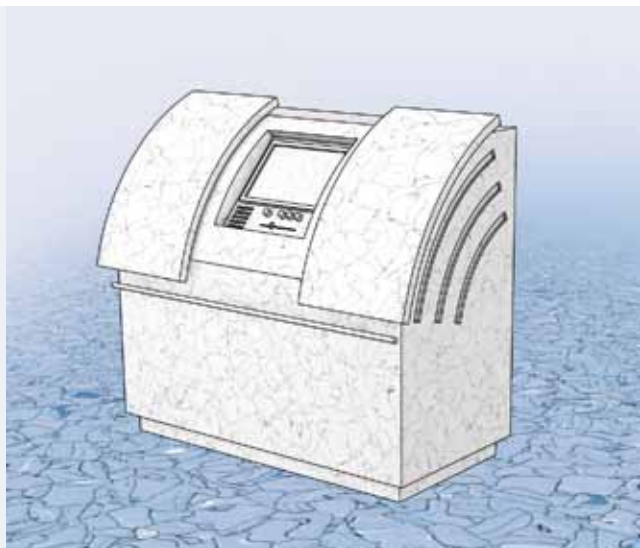

# Colorex SD Performance

Colorex SD enables safe electrostatic discharge through the whole thickness of the tile via the black conductive veins

**Functionality:** Permanently static dissipative

**Description:** Permanently static dissipative floor, connection between tiles through conductive adhesive and connected to earth through a copper strip.

**Application areas:** New build laboratories clean rooms, pharmaceutical laboratories, production sites, data centres, server rooms and operating theatres.



## Pre-formed internal and external corner pieces

These corners are moulded from Colorex material which has been reinforced on the reverse with resin to increase the durability. Designed to avoid the need to weld into corners, thereby providing installations that meet the requirements for cleanrooms.

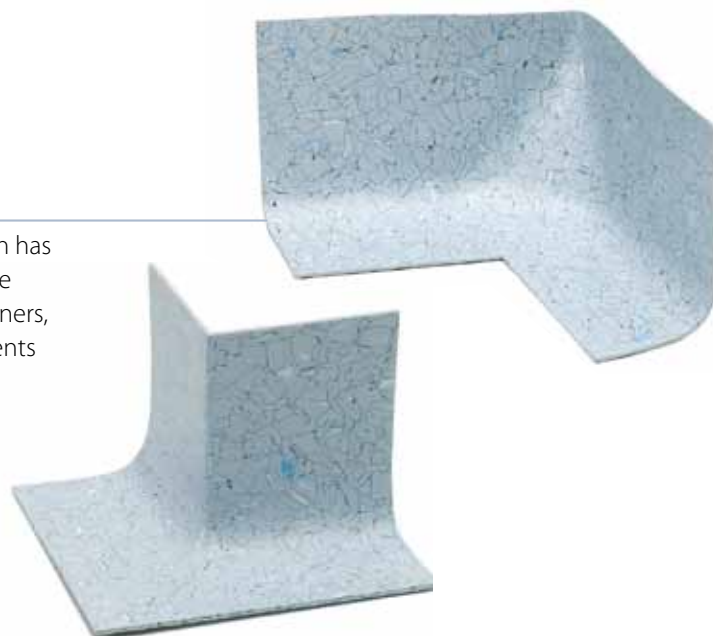



# Colorex EC plus

## High performance

**Colorex SD plus**  
(only available on request)

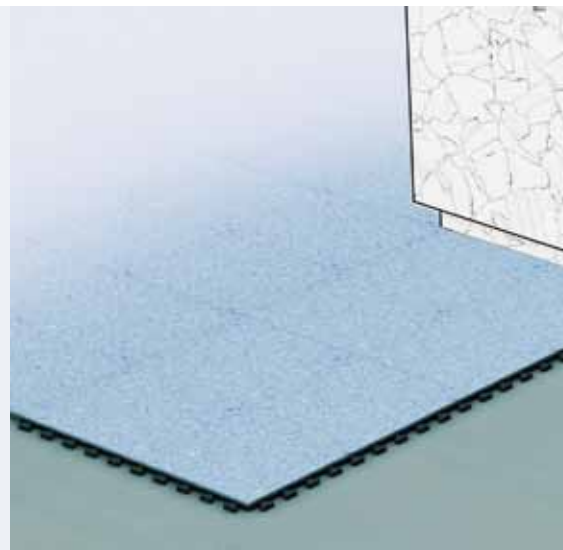

Renovating an industrial floor can be a very costly and labour intensive endeavour. The downtime needed to move or disassemble heavy production equipment and the cost of a complex subfloor renovation can begin to add up before work on installing the new floor has even started. Colorex EC plus is a high performance floor covering system that consists of loose lay tiles. Suitable for applications where

expensive preparatory measures and downtimes are not acceptable, it can be installed without any interruptions and is immediately accessible. There's no need for special subfloor treatments or preparations. The tiles connect to each other using a unique dovetailing system that remains hidden. As the tiles have a genuine Colorex surface you can still take advantage of its proven features and benefits.

### Skirting for Colorex plus

There are two types of skirtings available for the various versions of Colorex plus, each is designed to address a different solution. In hygiene critical areas, the proposed solution is similar to that used with 2 mm Colorex tiles with tailor made covered skirting which should be fitted by a skilled and trained installer. If Colorex plus has been fitted over a damp floor, we can provide a ventilated skirting that allows the humidity to escape into the room.

Radius 20 mm

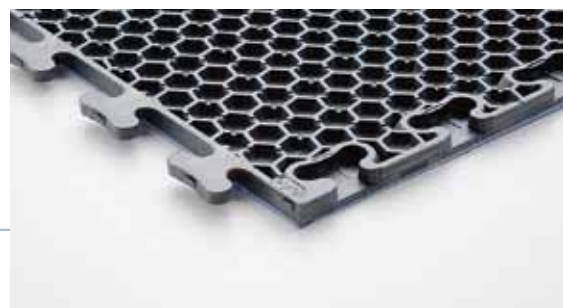



**Functionality:** Permanently conductive

**Description:** Permanently conductive floor, connection between tiles through dovetails and connected to earth with copper strip. Compliant to IEC 61340-4-5 with appropriate ESD shoes.

**Application areas:** Renovation of ESD facilities, cleanrooms, pharmaceutical laboratories and production sites. Suitable when down time, damp floors or poor sub floors are an issue.



#### Colorex ramp

In applications where Colorex plus has been installed as a stand alone working island or does not finish at a wall, access ramps are available in grey or colour matched to the main Colorex tile (Signal colours on request).



#### Colorex welding rods

All the accessories on this page and Colorex tiles can be welded with Colorex welding rod. These are available in colours to match the main Colorex tile.

In standard 4 mm diameter and 100 m coils





Colorex fully adhered directly to the floor



Colorex on top of a raised floor panel

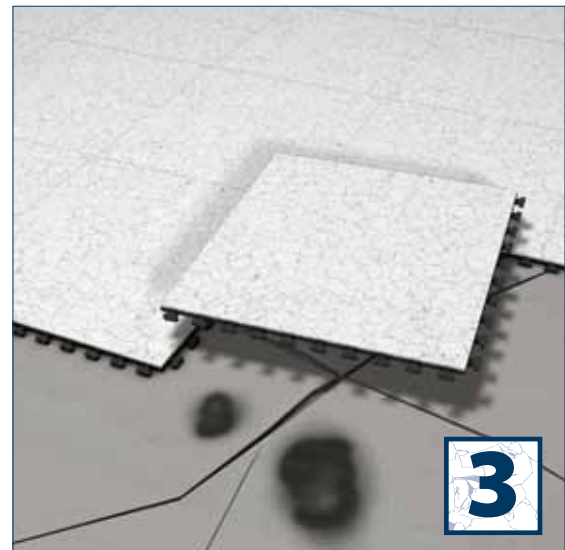

Colorex as loose lay tile

### 1. Colorex fully adhered directly to the floor

Colorex can be installed onto a solid subfloor. When conductive properties are required, this should be done by firstly using a conductive primer after which copper tape, connected to an earth point, and conductive adhesive is applied. When Colorex is installed using this process, the static charge is drained to earth via the earthing point. When conductivity is not required a standard primer and adhesive can be used. When installed on solid floors, Colorex can withstand heavy loads such as fork lift trucks without being damaged. The welding of Colorex tiles is optional for ESD areas however, is a requirement for cleanrooms. The unique dimensional stability of Colorex ensures no shrinkage and therefore, a correctly installed weld will never open up.

### 2. Colorex bonded to a raised access floor panel

Often Colorex is bonded to a raised access floor panel that can be used in cleanrooms or data centres. Due to the strength and unique properties of Colorex, it is suitable for use on all formats of raised access floor panels, including those designed to withstand the heavy point loading found in data centres. Since Colorex has extremely low emissions and a high density, it can be perforated for air flow systems that are often used in combination with raised access floors.

### 3. Colorex as loose lay tile

Colorex plus is a high performance floor covering system consisting of loose lay tiles for all areas of application where expensive sub floor preparation or downtime is an issue. Specific sub floor treatment or preparation is not necessary as long as the floor is reasonably level. Colorex plus can be installed without disruption of activities and it can be used immediately after installation, even by fork lift trucks. The unique honeycomb structure on the underside of Colorex plus allows damp floors to be ventilated during use. Colorex plus tiles offer all the benefits associated with Colorex along with a unique dovetail system that remains hidden under the surface. Colorex plus is available as an Electrical Conductive (EC) High performance version. Or it can be ordered on request as a Static Dissipative (SD) performance version. Additionally there is a standard version for installations where a high level of conductivity is not required. The Colorex plus collection is complemented with an R11 slip resistant option that can be used in conjunction with all other types of Colorex plus tiles for areas of heavy duty usage.

A range of specially developed ramps and skirtings are available for use with Colorex plus to provide a complete installation solution..

		<b>R11 plus</b>	
	<b>Functionality</b>	Slip resistant	
	<b>Description</b>	Dirt hiding, slip resistant floor.	
	<b>Application area</b>	Industrial areas, garages, warehouses. Suitable when down time, damp floors or poor sub floors are an issue	



# Colorex Basic plus Standard

**Colorex Basic**  
(only available on request)

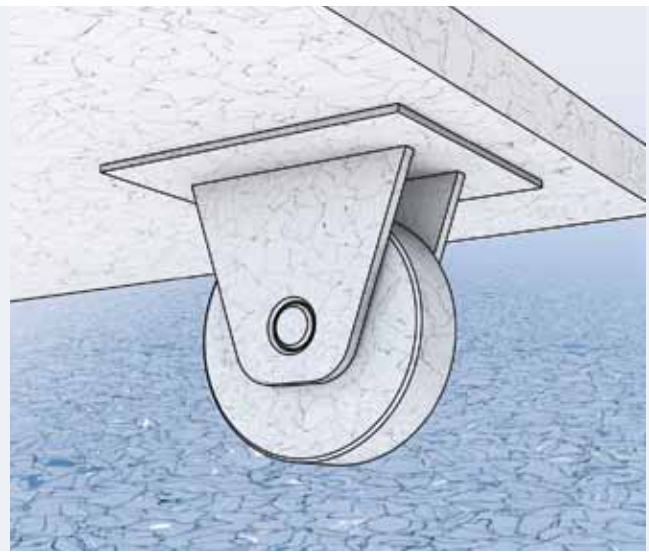

Colorex Basic plus is a loose lay floor system with a Colorex surface and limited conductive properties. This range provides all the benefits of Colorex, such as a high density, repairable and chemical resistant surface with the flexibility of a heavy duty loose lay tile.

**Functionality:** Resistant / repairable

**Description:** Excellent chemical resistance. Floor can be repaired in case of heavy damages.

**Application areas:** Shops, stores, warehouses. Suitable when down time, damp floors or poor sub floors are an issue





# R11 plus

The product has enhanced slip resistance, categorised as, R11 due to its strong surface embossed structure. Only available in colourway 601060.

**Functionality:** Slip resistant to R11

**Description:** Dirt hiding, slip resistant floor.

**Application areas:** Industrial areas, garages, warehouses. Suitable when down time, damp floors or poor sub floors are an issue



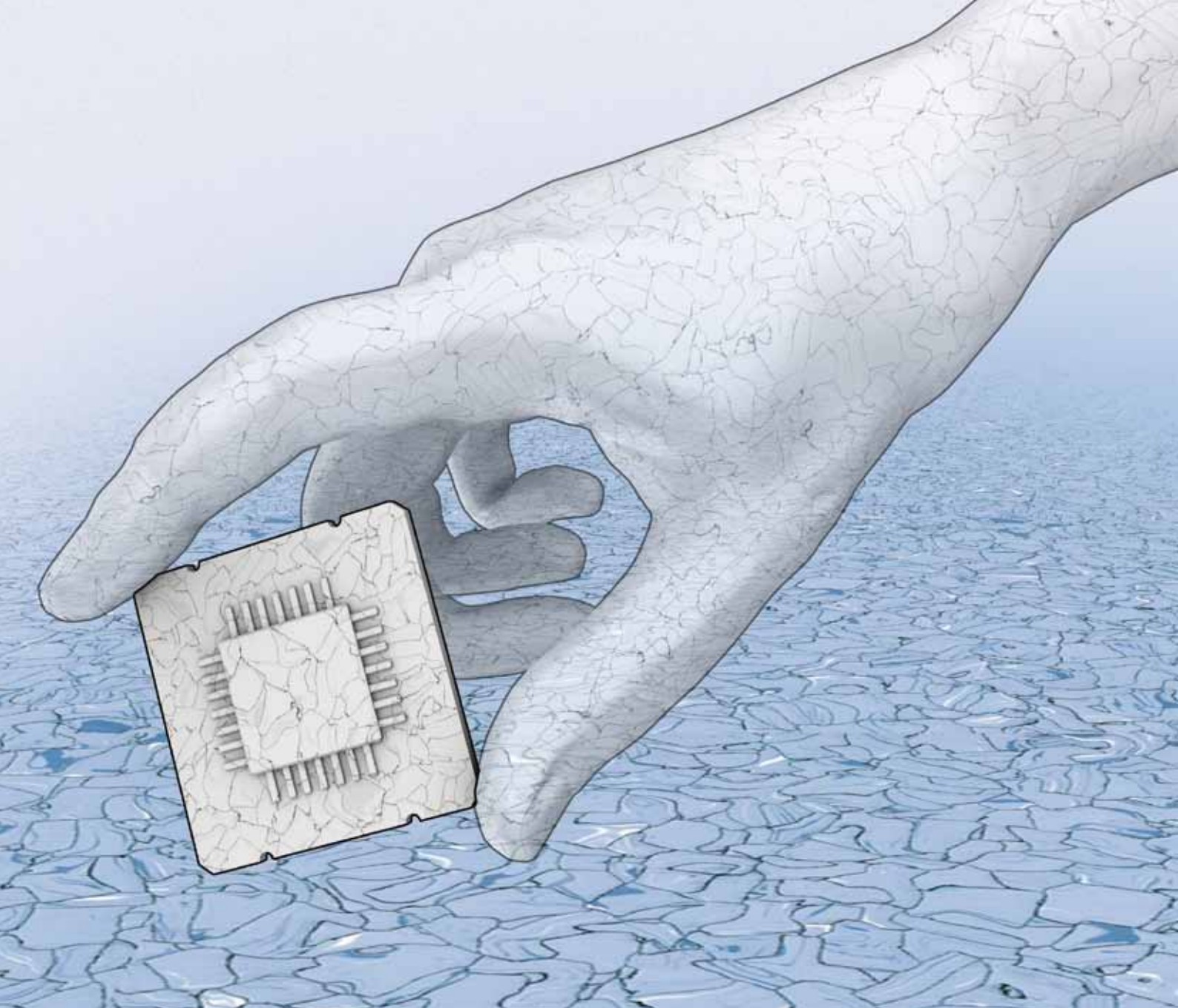

# ESD flooring that's future proof

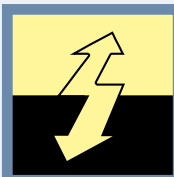

Lifetime  
Conductivity  
Warranty



Electrostatic  
Discharge Flooring  
(ESD)

**Products:**

- Colorex SD
- Colorex EC
- Colorex EC plus



### **The right floor makes the difference**

Reducing the generation of electrostatic charges is the main purpose of control measures in ESD protected areas (EPA). In such areas like electronics assembly, mechatronics and data centres the right floor covering plays a crucial role. It does not only drain electrostatic charges from personnel and equipment, but it also reduces the generation of charges where they occur ie at the interface between the soles of shoes and the floor.

### **Consistent conductivity throughout the product's lifetime**

The unique construction of Colorex EC and Colorex SD ie completely free from volatile chemicals, ensures the permanent and stable conductive performance of the floor over its entire life time, regardless of changes in humidity and temperature.

### **We guarantee more than resistance**

Forbo Flooring guarantees consistent performance. We measure the electrical resistance of every single production batch of Colorex EC and Colorex SD and upon request, we can provide a test report clearly showing the results of our measurements.

### **Low body voltage generation**

It is a natural phenomena that anybody can accumulate an electrostatic charge just by the simple motion of walking. By wearing the appropriate ESD shoes however, these charges will be securely drained through the dense network of conductive veins of Colorex EC and Colorex SD.

# Cleanroom flooring for the highest standards



## Products:

- Colorex SD
- Colorex EC
- Colorex EC plus

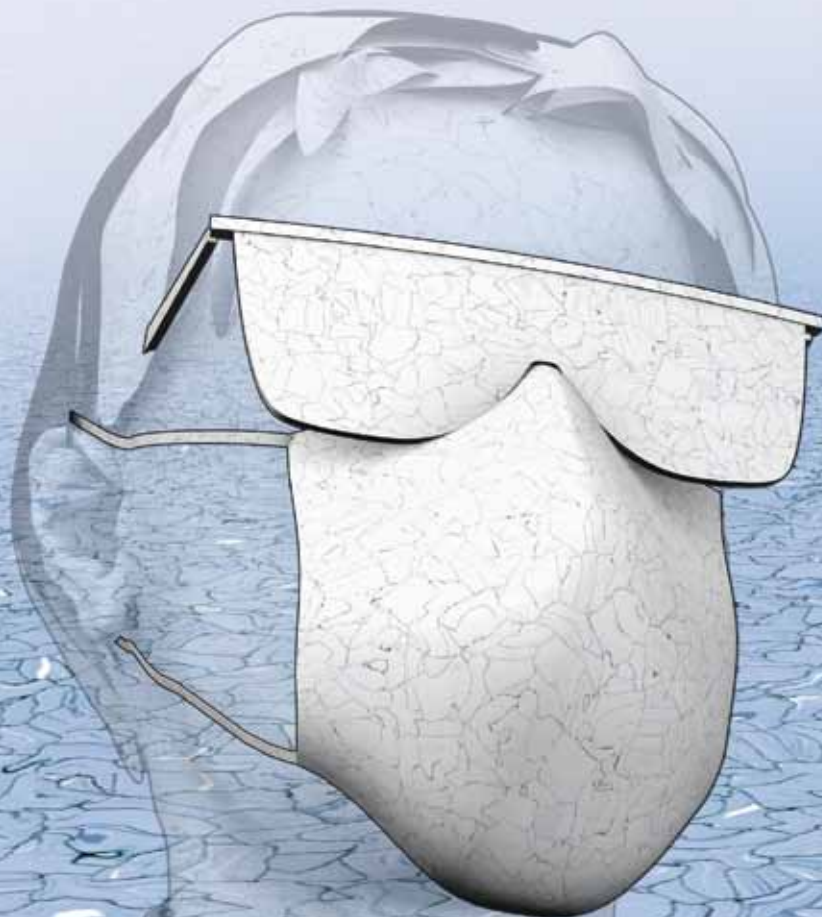



In cleanroom environments in the pharmaceutical, life sciences and manufacturing industries, airborne particles can be a major source of contamination. Not only can they cause yield loss, the particles can also lead to corrosion and product degradation. ISO standards and cGMP regulations for air purity require you to comply by presenting consistent results that can be verified on a regular basis. Ideal for cleanrooms and these kinds of environments, Colorex satisfies the strictest requirements for particle release behaviour, helping to reduce any threat of contamination. What's more, following a comprehensive programme of testing, its suitability in cleanroom applications has been certified by the renowned Fraunhofer IPA Institute in Germany.

**Colorex EC was tested for the following:**

- Airborne particle emission test and cleanroom suitability (ISO 14644-1)
- Outgassing analysis and classification (ISO 14644-8)
- Adhesion of microorganisms
- Assessment of microbial metabolic potential (ISO 846)
- Chemical resistance (ISO 2812-1)
- Cleanability rating (VDI guideline 2083 Part 4)
- cGMP classification complying to Class A



# Hygiene and safety for sensitive hospital areas

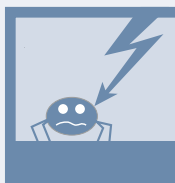

Pore-free surface  
inhibits bacteria  
and moulds



Resistant to  
chemicals

**Products:**

- Colorex SD
- Colorex EC
- Colorex EC plus

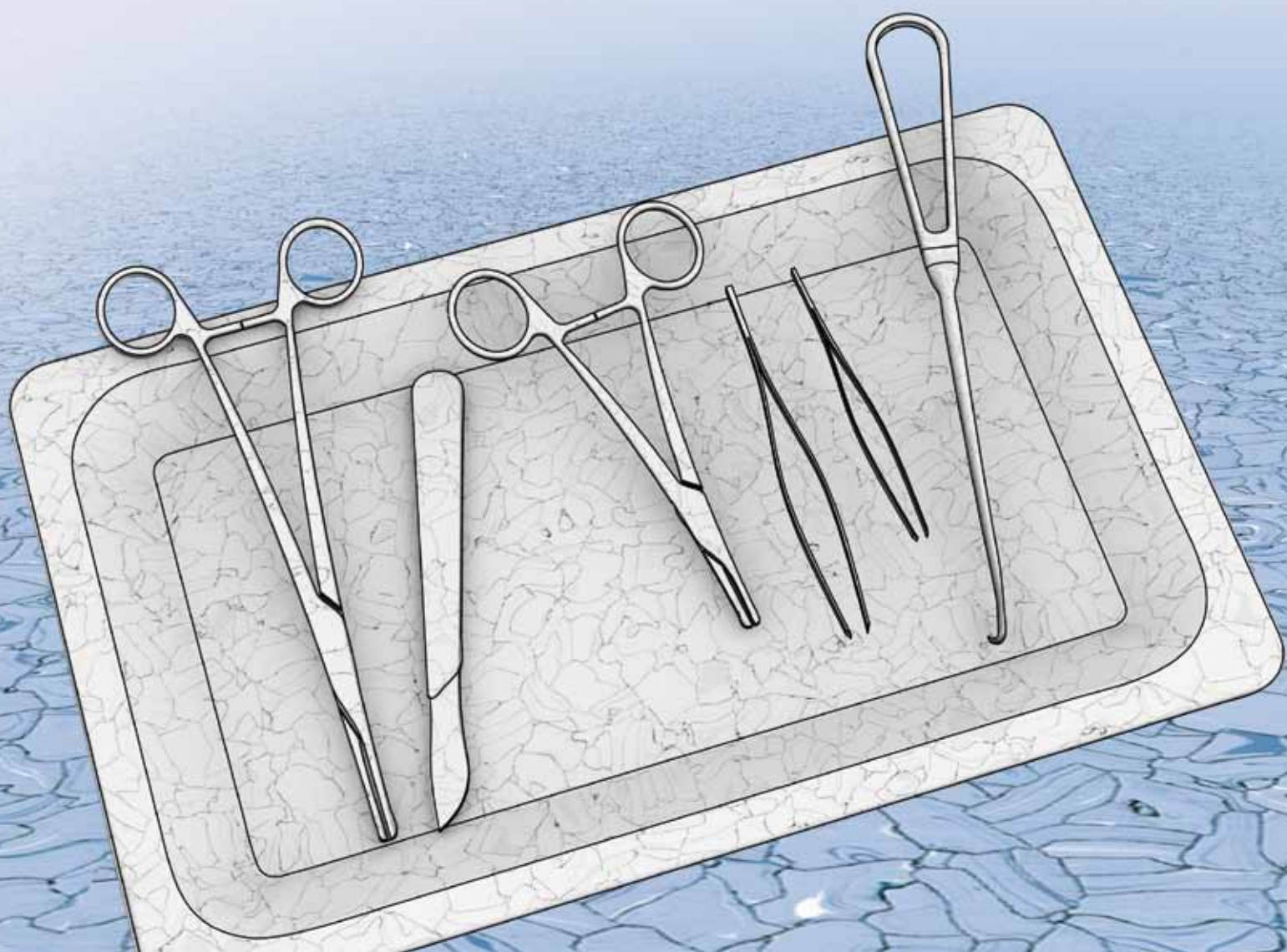

### **A demanding area**

In sensitive hospital areas such as operating theatres, intensive care units and imaging diagnostic facilities, flooring presents its own unique challenges. Not only must it comply with stringent hygiene regulations to help prevent hospital acquired infections, it must also demonstrate that it meets any necessary safety requirements. Most importantly, it must prevent any electrostatic discharges as these can cause malfunctions, or even failures, in highly sensitive medical equipment and devices.

### **The highest standards of hygiene**

Colorex satisfies all these requirements. Its conductive properties allow you to avoid the negative effects of an accumulation of static electricity. At the same time, the compact, pore-free surface is unfriendly to bacteria and moulds, helping you to maintain the highest standards of hygiene. Thanks to its excellent stability and consistent high quality, its aesthetic appeal won't be tarnished by the regular cleaning and disinfecting cycles that are imperative in hospital environments. Colorex is highly stain resistant helping to ensure your investment will still look good in years to come.



# Industrial flooring for heavy duty areas

KG

Powered pallet truck and forklifts



Repairable and restorable solution. No downtime

**Products:**

- Colorex SD
- Colorex Basic plus
- R11 plus

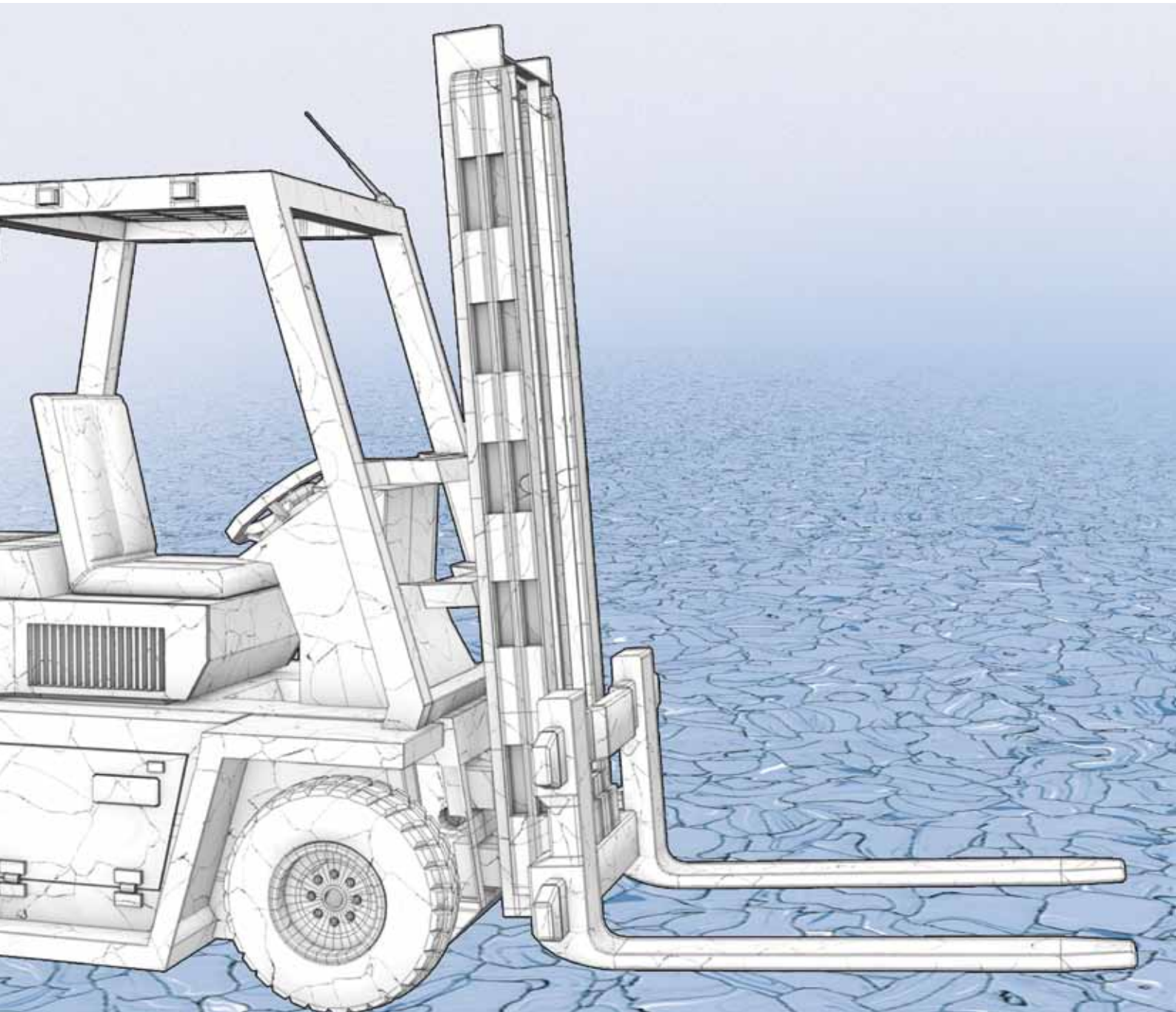

### Suitable for the most demanding applications

Industrial environments present their own flooring problems, particularly in areas with high wear and tear. Our Colorex high performance floor covering systems are designed for all industrial areas, including the most demanding of applications. Cut from a homogeneous, solid block of highly compressed material they have a high vinyl content and a well balanced amount of mineral filler for optimum performance.

### Colorex offers you:

- High mechanical resistance and wear with no need for factory coating or additional surface hardening treatments
- Excellent chemical resistance thanks to the pore-free surface and a remarkably low percentage of plasticiser
- A 100 % repairable and restorable solution that leaves no trace of abrasive treatment methods



# The finishing detail – hygienic and aesthetic

In hygiene sensitive areas, Colorex finishes not only look attractive but are in many cases, a must from a hygienic point of view. The use of preformed corners and skirtings provides the perfect solution in terms of freedom of design combined with ease of maintenance.



The Colorex accessories have, amongst other benefits, preformed corners with a radius linked to the size of cleaning pads found on most commercial cleaning machines. This ensures that no sharp corners are created that would prove difficult to clean. Preformed outer corners are prevented

from tearing because of their special construction. The inner reinforcement prevents the outer corners tearing or breaking due to high mechanical pressure, e.g. the rotation of a cleaning machine

# Colorex collection

etna



SD 150240 | EC 250240

everest



SD 150201 | EC 250201

adula

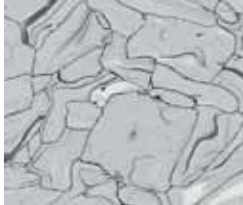

SD 150205 | EC 250205  
EC plus 621005  
Basic plus 611005

pacific



SD 150221 | EC 250221

kiwi



SD 150225 | EC 250225

sahara



SD 150213 | EC 250213  
EC plus 621013  
Basic plus 611013

kilimanjaro

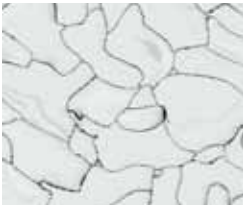

SD 150203 | EC 250203

moonstone

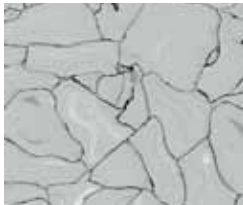

SD 150206 | EC 250206

niagara

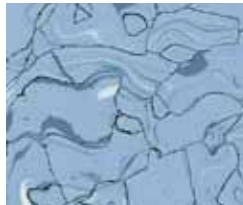

SD 150222 | EC 250222  
EC plus 621022  
Basic plus 611022

twilight



SD 150234 | EC 250234

oasis



SD 150215 | EC 250215

ivory



SD 150202 | EC 250202

quartz



SD 150207 | EC 250207  
EC plus 621007  
Basic plus 611007

atlantic

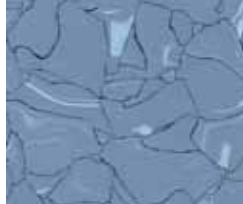

SD 150223 | EC 250223

jade

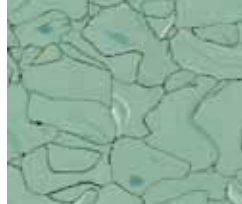

SD 150236 | EC 250236

assuan



SD 150219 | EC 250219

montblanc



SD 150204 | EC 250204  
EC plus 621004  
Basic plus 611004

granite

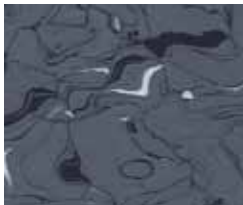

SD 150208 | EC 250208

cobalt

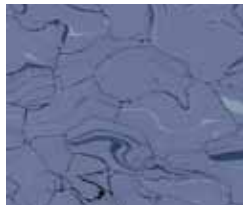

SD 150224 | EC 250224

musk

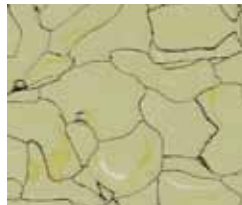

SD 150232 | EC 250232

lux



SD 150212 | EC 250212

## Signal

fuego



SD 150233

azzurro



SD 150235

amazonas



SD 150237

sole



SD 150231



















## R11 plus



601060





# Technical specifications Colorex

Colorex meets the requirements of EN 649

		Colorex SD	Colorex EC	Colorex EC Plus	Colorex Basic Plus	R11 Plus
 CE marking	EN 14041	Compliant	Compliant	Compliant	Compliant	Compliant
ASTM**		Compliant	Compliant			
 Total thickness	ISO 24346 / EN 428	2.0 mm / 3.0 mm*	2.0 mm / 3.0 mm*	10.5 mm	10.5 mm	10.5 mm
 Tile size	EN 427	615x615 mm 615x1230 mm*	615x615 mm 615x1230 mm*	608x608 mm	608x608 mm	608x608 mm
 Commercial very heavy	ISO 10874 / EN 685	34	34	34	34	34
 Industrial heavy	ISO 10874 / EN 685	43	43	43	43	43
 Electrical resistance	IEC 61340-4-1 EN 1081 (100V) ANSI/ESD 7.1	$10^6 \leq R \leq 10^8 \Omega$	$5 \times 10^4 \leq R \leq 10^6 \Omega$	$2.5 \times 10^4 \leq R \leq 10^6$	n.a.	n.a.
 Electrical resistance in combination with ESD Shoes	IEC 61340-4-5 ESD STM 97.1	n.a.	$R < 3.5 \times 10^7 \Omega$	$R < 3.5 \times 10^7 \Omega$	n.a.	n.a.
 Outgassing	IDEMA M11-99	total < 1 µg/cm <sup>2</sup>	total < 1 µg/cm <sup>2</sup>	total < 2 µg/cm <sup>2</sup>	total < 2 µg/cm <sup>2</sup>	n.a.
Total TVOC 28 days Total TSVOS 28 days	AgBB guidelines	< 1 mg/m <sup>3</sup> < 0.1 mg/m <sup>3</sup>	< 1 mg/m <sup>3</sup> < 0.1 mg/m <sup>3</sup>	< 1 mg/m <sup>3</sup> < 0.1 mg/m <sup>3</sup>	< 1 mg/m <sup>3</sup> < 0.1 mg/m <sup>3</sup>	n.a.
 Bacteriostatic	SNV 195 920	Pass	Pass	Pass	Pass	n.a.
 Chemical resistance	ISO 26787 / EN 423	Excellent	Excellent	Excellent	Excellent	Excellent
 Slip resistance	DIN 51130	R9	R9	R9	R9	R11
 Total weight	ISO 23997 / EN 430	3.2 kg/m <sup>2</sup>	3.2 kg/m <sup>2</sup>	12.4 kg/m <sup>2</sup>	12.4 kg/m <sup>2</sup>	11.4 kg/m <sup>2</sup>
 Dimensional stability	ISO 23999 / EN 434	0.05%	0.05%	n.a.	n.a.	n.a.
Thermal dilatation coefficient		n.a.	n.a.	0.11 mm/m°C	0.11 mm/m°C	0.11 mm/m°C
 Residual indentation	ISO 24343-1 / EN 433	0.035 mm	0.035 mm	n.a.	n.a.	n.a.
Resistance to loads (performance may vary, subject to local conditions)		n.a.	n.a.	Powered pallet truck and forklifts: total weight up to 2.5 t with hard wheels and up to 5 t with air tyres. Static loads: 50 kg/cm <sup>2</sup> - dynamic loads: 90 kg/cm <sup>2</sup>		
 Abrasion resistance	EN 660-2	Group M	Group M	Group M	Group M	n.a.
 Castor chair continuous use	ISO 4918 / EN 425	no effect	no effect	no effect	no effect	n.a.
 Light fastness	EN ISO 105 B02	≥ 6	≥ 6	≥ 6	≥ 6	n.a.
 Impact sound reduction	EN ISO 140-8	2 dB	2 dB	12 dB	12 dB	12 dB

All Colorex products meet the requirements of EN 14041



 Body voltage generation, with appropriate ESD shoes	IEC 61340-4-5 ESD STM97.2 EN 1815	40 V	20 V	20 V	< 2 kV	< 2 kV
 Reaction to fire	EN 13501-1	B <sub>f</sub> -s1	B <sub>f</sub> -s1	B <sub>f</sub> -s1	B <sub>f</sub> -s1	B <sub>f</sub> -s1
 Slip resistance	EN 13893	μ = 0.60	μ = 0.60	μ = 0.60	μ = 0.60	n.a.
 Thermal conductivity	EN 12524	0.28 W/(m·K)	0.28 W/(m·K)	0.28 W/(m·K)	0.28 W/(m·K)	0.28 W/(m·K)

\* Available on request

\*\* Product also tested to ASTM. Results available on request

The quality and environmental management system of Forbo Giubiasco S.A. (CH) where Forbo Colorex is manufactured are certified in accordance with ISO 9001 and ISO 14001





# The repairable surface

Deep scratches, holes, burns or other surface damage can be easily and effectively repaired, without leaving any visible trace or affecting the original characteristics of the floor. This genuine, 100% repairable surface is unique to Colorex and something that no other flooring system can promise.

## Invisible repairs

Deep scratches and other serious damage can be repaired by hot welding. A small strip of Colorex of the same colour should be welded directly into the damage using a hand welding machine. After the excess material has been trimmed off, the repaired spot can be restored to a good-as-new condition by sanding and dry polishing.

- **Unique 100% repairable surface**
- **Scratches or serious damage can be solved**
- **It will be restored to a good-as-new condition**

## Repair

**Problem:** Deep and long scratches, holes and burns

**Advantage:** Invisible repairs without damaging the initial characteristics of the product

**Reason:** Perfect homogenous product with low plasticiser content



Damage

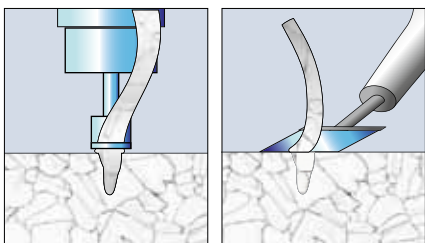

Hot welding and material trimming

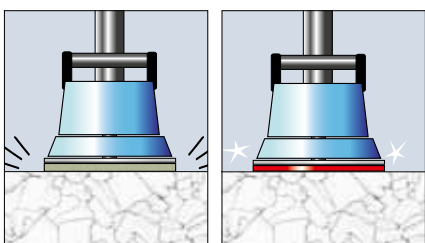

Sanding and dry polishing

## Maintenance

Surface damage such as burns or discoloration from chemicals can be removed by sanding with a conventional eccentric sander. Use a sand paper grade of 80 to start with and thereafter grades of up to 240. After sanding, the surface can be restored to its original quality and appearance by dry polishing with a red pad.

- **Easy sanding with conventional equipment**
- **Restore to its original quality and appearance by simply polishing**

## Abrasive cleaning

**Problem:** Surface damage like burns, abrasion or staining

**Advantage:** Abrasive cleaning possible

**Reason:** Thanks to a compact high pressure pressed surface a PUR treatment is not necessary

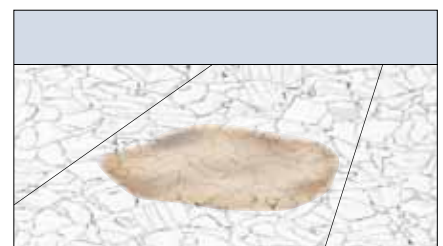

Damage

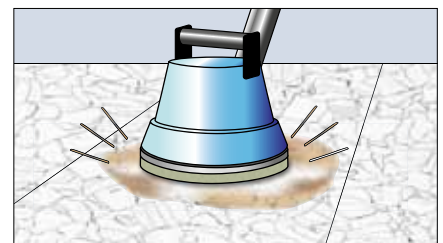

Sanding

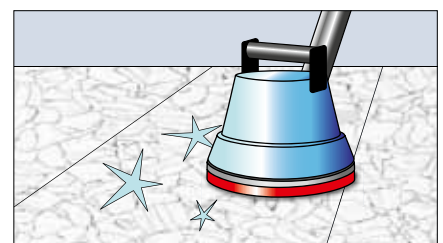

Polishing

Forbo Flooring Systems is part of the Forbo Group, a global leader in flooring, bonding and movement systems, and offers a full range of flooring products for both commercial and residential markets. High quality linoleum, vinyl, textile, flocked and entrance flooring products combine functionality, colour and design, offering you total flooring solutions for any environment.



**UK**  
Forbo Flooring UK Limited  
P.O. Box 1, Kirkcaldy, Fife KY1 2SB  
**London EC1 showroom**  
79 St John Street, Clerkenwell  
London EC1M 4NR  
Tel: 0207 553 9300

**For commercial enquiries:**  
If calling from the North,  
Midlands, London & South East  
Tel: 0800 0282 162  
Fax: 01772 646 912

If calling from Scotland & South West  
Tel: 0800 0935 258  
Fax: 01592 643 999

**Nuway enquiries:**  
Tel: 01773 740 688  
Fax: 01773 740 640

**Residential enquiries:**  
Tel: 0800 0935 846  
Fax: 01592 643 999

Email: [info.flooring.uk@forbo.com](mailto:info.flooring.uk@forbo.com)  
[www.forbo-flooring.co.uk](http://www.forbo-flooring.co.uk)

**Samples:**  
Tel: 0800 731 2369

**Ireland**  
Forbo Flooring UK Ltd.  
2 Deansgrange Business Park  
Blackrock  
Co Dublin  
Tel: 00353 1 2898 898  
Fax: 00353 1 2898 177

E-mail: [info.ireland@forbo.com](mailto:info.ireland@forbo.com)  
[www.forbo-flooring.ie](http://www.forbo-flooring.ie)

**Registered office:**  
Forbo Flooring UK Limited  
Den Road, Kirkcaldy  
Fife KY1 2ER  
Registered in Scotland: No 41400

